



# User Manual

## Catalog

<b>1. Packing list</b> . . . . .	<b>01</b>		
<b>2. Parts and names</b> . . . . .	<b>01</b>		
2.1 Front panel . . . . .	01		
2.2 Rear panel . . . . .	02		
2.3 Home screen . . . . .	02		
2.4 Remote control . . . . .	03		
<b>3. Connections</b> . . . . .	<b>04</b>		
3.1 Connect to AC power . . . . .	04		
3.2 Connect to input source . . . . .	05		
3.3 Connect to active speakers or power amplifiers . . . . .	05		
3.4 Connect other devices via Trigger . . . . .	06		
3.5 Connect to network . . . . .	06		
<b>4. Play</b> . . . . .	<b>10</b>		
4.1 Basic operations . . . . .	10		
4.1.1 Power on and standby . . . . .	10		
4.1.2 Select input source . . . . .	10		
4.1.3 Volume control . . . . .	10		
4.1.4 Mute/unmute . . . . .	11		
4.1.5 Filter settings . . . . .	11		
4.1.6 Set SYNC mode . . . . .	11		
4.1.7 Dimmer . . . . .	11		
4.1.8 Auto standby . . . . .	11		
4.1.9 Remote control . . . . .	12		
4.2 Play music via optical, coaxial or IIS-LVDS port . . . . .	13		
4.3 Play music via USB Audio port . . . . .	13		
4.4 Airplay . . . . .	14		
<b>5. Settings</b> . . . . .	<b>17</b>		
<b>6. Appendix</b> . . . . .	<b>17</b>		
6.1 About MQA . . . . .	17		
6.2 IIS-LVDS Port . . . . .	17		
6.3 Technical Specifications . . . . .	18		
6.4 Power supply . . . . .	19		
6.5 Other specifications . . . . .	19		

## 1. Packing list

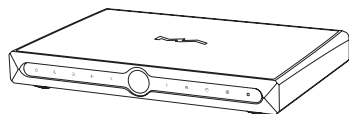

1

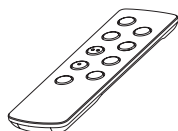

2

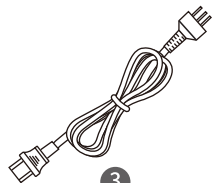

3



4

1. Product x1

2. Remote control x1

3. Power cord x1

4. Lithium battery x1\*

\* Due to regulatory restrictions, it may not be provided in some cases.

## 2. Parts and names

### 2.1 Front panel

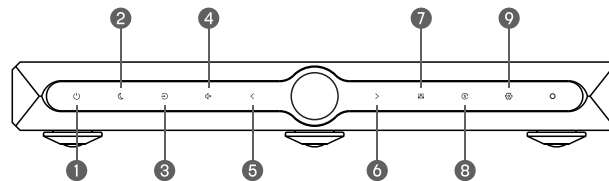

1. Power on/Standby

2. Dimmer

3. Input

4. Mute/Unmute

5. Volume-/Left arrow

6. Volume+/Right arrow

7. Filter

8. SYNC mode

9. Settings menu

## 2.2 Rear panel

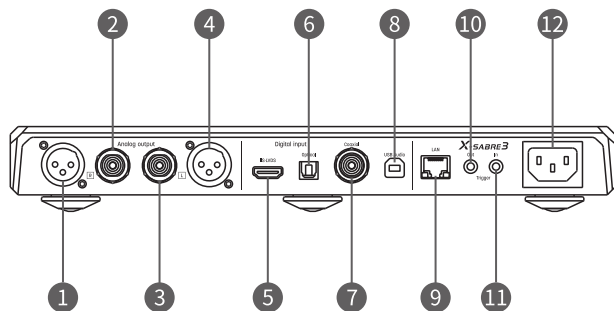

- |                            |                            |
|----------------------------|----------------------------|
| 1. Right XLR analog output | 2. Right RCA analog output |
| 3. Left RCA analog output  | 4. Left XLR analog output  |
| 5. IIS-LVDS input          | 6. Optical input           |
| 7. Coaxial input           | 8. USB audio input         |
| 9. Ethernet                | 10. Trigger output         |
| 11. Trigger input          | 12. AC input               |

## 2.3 Home screen

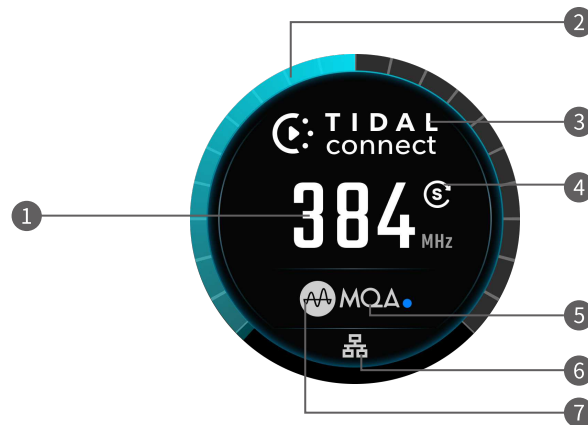

- |                  |                   |
|------------------|-------------------|
| 1. Sampling rate | 2. Volume ring    |
| 3. Input channel | 4. SYNC mode      |
| 5. Audio format  | 6. Network status |
| 7. Filter type   |                   |

## 2.4 Remote control

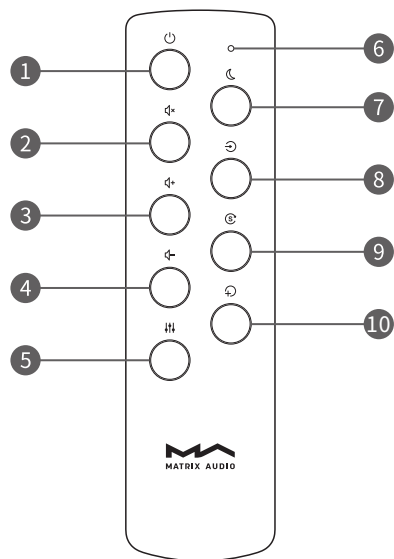

1. Power on/Standby
2. Mute/Unmute
3. Volume +
4. Volume -
5. Filter
6. Working/Battery LED
7. Dimmer
8. Input
9. SYNC Mode
10. Shortcut

## 3.Connections

### 3.1 Connect to AC power

X-SABRE 3 is compatible with AC100-120V and AC220-240V power specifications. Please make sure to select correct voltage option to match your local power before connecting the unit to powersupply.As shown:

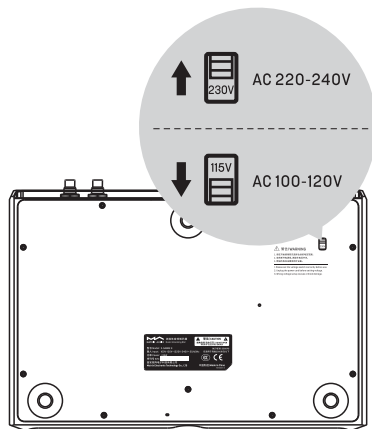

The two options 115V and 230V are stands for:

The 115V option is fit for AC100V-120V 50/60Hz

The 230V option is fit for AC220V-240V 50/60Hz

Please use the power cable which includes an Earth wire. Ensure you have a reliable Earth wire connection to avoid an electrical shock.

Please unplug the power cable if you need the unit to be disconnected from the mains completely.

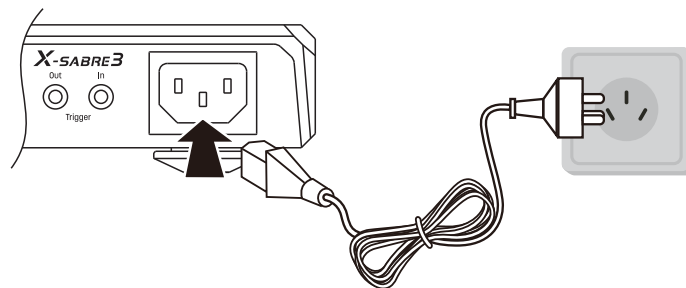

### 3.2 Connect to input source

You can connect the X-SABRE 3 to S/PDIF output devices via coaxial and optical port, or connect to an audio interface from Matrix X-SPDIF 2 via IIS-LVDS port.

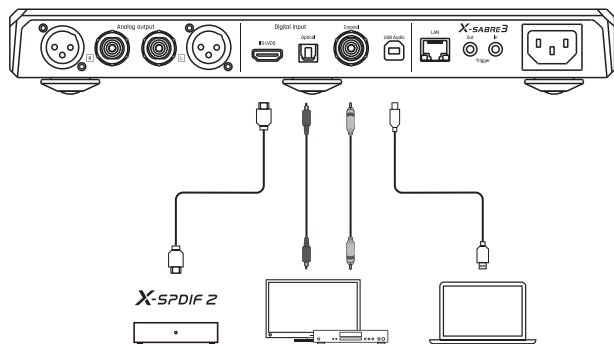

### 3.3 Connect to active speakers or power amplifiers

The X-SABRE 3 can be connected to active speakers or amplifiers via RCA or XLR cables. In order to avoid damage to your devices, please turn off the active speakers or amplifiers before connecting them to X-SABRE 3.

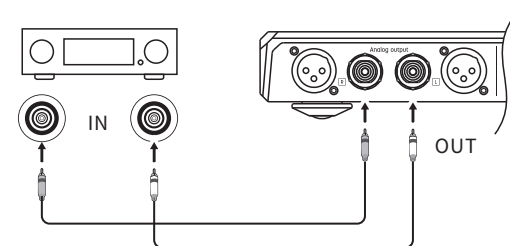
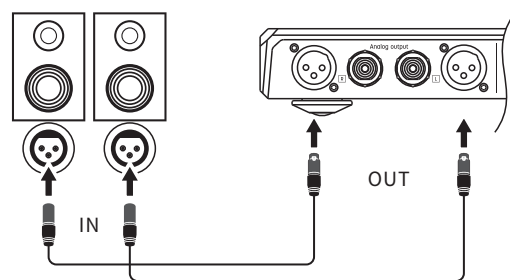

### 3.4 Connect other devices via Trigger

#### • Trigger In

X-SABRE 3 accepts trigger signal from the Trigger Out of other devices. Connect X-SABRE 3 to a device with a Trigger Out to achieve the power linkage of this unit and other devices.

#### • Trigger Out

Connect X-SABRE 3 to a device with a Trigger In to achieve the power linkage of this unit and other devices.

#### • Cables

Use a non-resistance cable with 1/8 inch (3.5 mm) mono plugs for trigger connection. Do not use a cable with stereo plugs for this purpose.

### 3.5 Connect to network

#### • Connect to Ethernet

X-SABRE 3 supports 1000Mbps Ethernet connection, a CAT-6 or higher version shielded Ethernet cable is recommended. Connect X-SABRE 3 to the network router with Ethernet cable, and let the unit in the network as shown below:

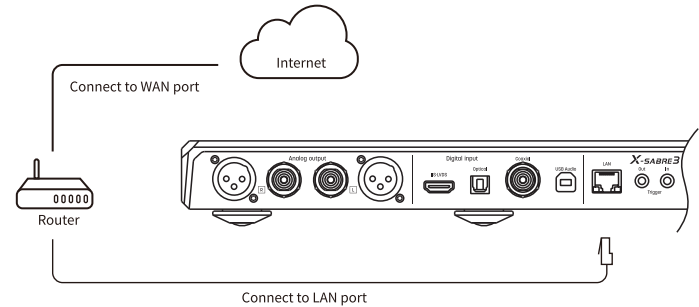

Enter the 13th option "Network" in Settings menu, select "LAN" as shown below:

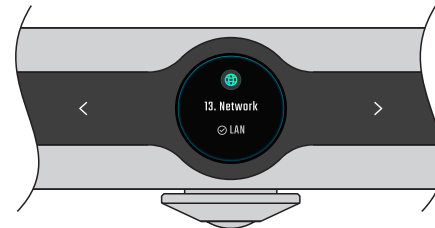



It is recommended to set up the router as DHCP server, the unit will be assigned an IP address automatically. After joining the network, there will be an Ethernet icon shown on the screen. As shown below:

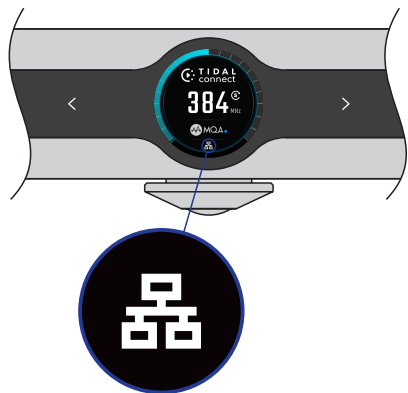

• Connect to WLAN

Let the X-SABRE 3 in the network as shown below:

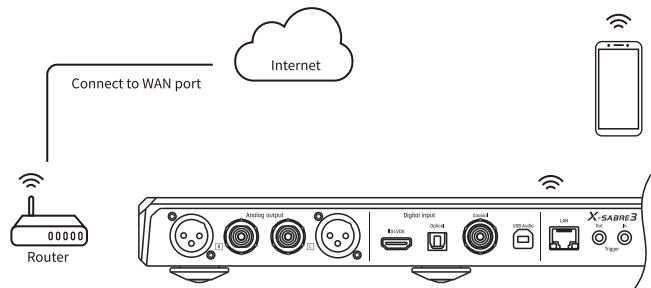

Enter the 13th option "Network settings" in Settings menu, select "Wi-Fi" as shown below:



After the network search is completed, use the " < " or " > " touch-key to select the SSID to be connected. X-SABRE 3 supports 2.4g/5g wireless network.

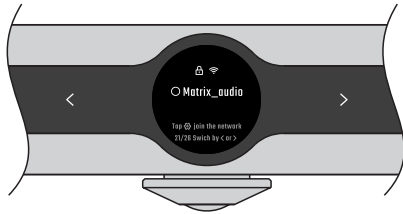

Tap the " [enter] " touch-key to enter the password input interface, tap the " < " or " > " touch-key to switch characters. " # " touch-key to select a character and " [enter] " touch-key to switch the keyboard.

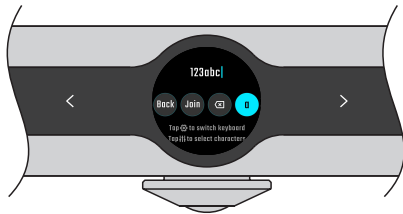

After entering the password, select "Join" to start connecting to this wireless network.

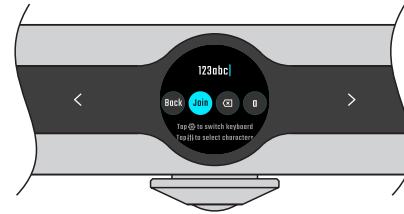

After joining the wireless network, there will be a wireless network icon shown on the screen. As shown below:

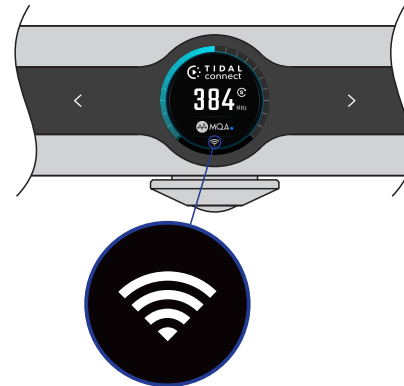

The antennas for wireless connection are located in the area shown in the figure below, to ensure a good signal, please do not place metal objects in this area on the top of the unit.

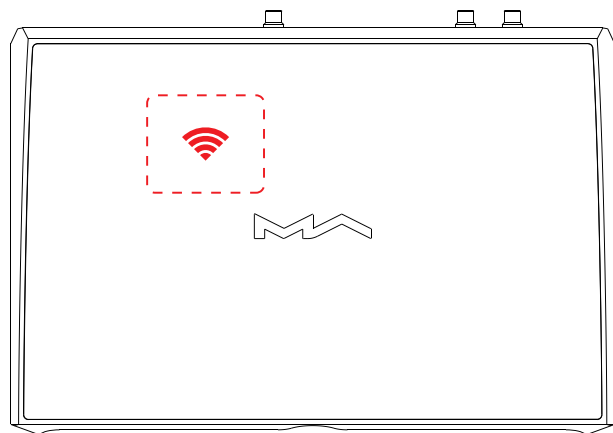

When the connected Ethernet or WLAN is not connected to the internet, the Home screen will display a yellow icon, as shown below:

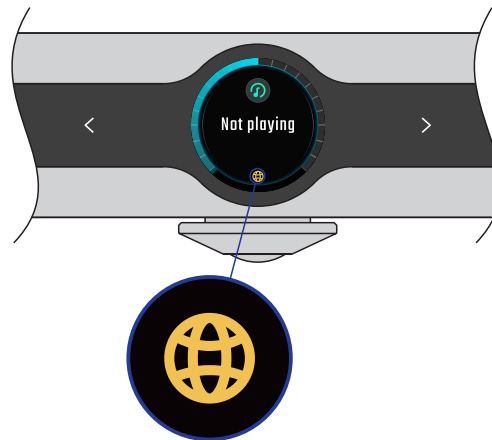

## 4. Playback

### 4.1 Basic operations

#### 4.1.1 Power on and standby

After connecting to the power supply, touch the "⏻" touch-key on the device. After hearing the beep for a few seconds, the screen will light up and LCD screen the startup bar. The first startup after connecting to the power supply will take about 30 seconds. Without disconnecting the power supply, the time of start up will be less than 5 seconds. Tap and hold the "⏻" touch-key on the unit or the remote control for about 2 seconds, or short press the "⏻" touch-key to enter Standby mode.



#### 4.1.2 Select input source

At Home screen, tap "⊞" touch-key, tap the "<" and ">" to select input channels between coaxial, optical, IIS-LVDS, USB Audio and streaming, tap the "⊞" touch-key again to confirm and go back to the Home screen.

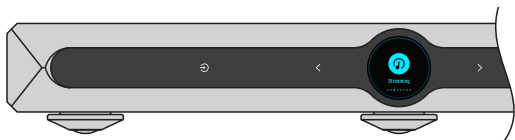

#### 4.1.3 Volume control

At Home screen, tap the "<" and ">" touch-key to adjust the volume step by step, tap and hold the touch-key to adjust volume rapidly. The screen will display current volume by dB.



When the Lineout mode was set to "Fixed", the volume cannot be adjusted, there will be no volume ring on the Home screen.



#### CAUTION:

"Fixed" output means that the device outputs a maximum level signal at 0dB. Before selecting this mode, make sure that your power amplifier or active speakers have been adjusted to a lower volume level. If the amplifier or speakers do not have volume control, do NOT set to "Fixed" output mode, otherwise this operation may damage to your devices and harm to your ears.

#### 4.1.4 Mute/Unmute

Tap the "⏸" touch-key at Home screen to mute the device, tap it again or tap the "< "and" >" touch-key to unmute. It can also be unmute by pressing the "⏸"; "⏸" or "⏸" button on the remote control.

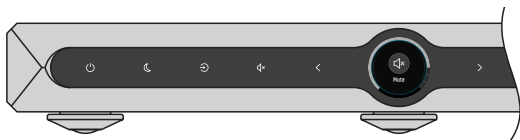

#### 4.1.5 Filter setting

At Home screen, tap the "≡" touch-key to select PCM/DSD filters. Tap once to set PCM filter, tap again to set DSD filters, use the "< "or" >" touch-key to select filters, tap the "≡" touch-key again to confirm it and back to Home screen.



#### 4.1.6 Set SYNC mode

At Home screen, tap the "⊗" touch-key to let the D/A chip work at synchronous or asynchronous modes. When the D/A mode was set to synchronous mode, there will be a SYNC mode icon on the screen.



#### 4.1.7 Dimmer

In order to avoid interference from the LED and the LCD screen tap the "⏻" touch-key at Home screen, the LED of all the touch-keys will be turned off, and at the same time, the brightness of the LCD screen will be dimmed. Tap any touch-keys to quit Dimmer mode.

#### 4.1.8 Auto standby

When the optical, coaxial, USB Audio and IIS-LVDS input channel is selected, the input signal not locked, there is not any touch-keys or remote control operations, and the duration of such state reaches the set auto standby time, then it will automatically standby. When the streaming input channel is selected, no playing, there is not any touch-keys or remote control operations, and the duration of such state reaches the set auto standby time, then it will automatically standby.

#### 4.1.9 Remote control

The remote control uses a CR2032 battery, install the battery in the battery holder at bottom of the remote control. Please note the polarity.

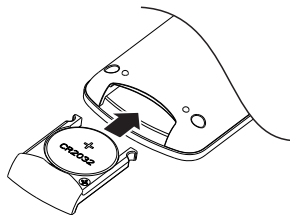

Point the remote control to the IR remote receiver like in the following picture, the remote distance is about 8 meters and the battery life is about 1 year. When the battery is low, the Working indicator on the remote control flashes red, the screen will also remind you to replace the battery.

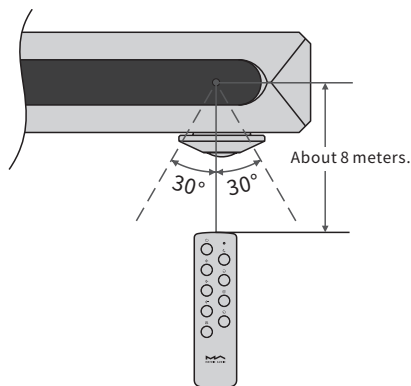

The remote control has a shortcut button. It can be defined as any input channels or filters in the Settings menu, which is convenient for you to quickly operate frequently used items, and it also can be set to OFF.

If there are more than one MATRIX device in the same environment, in order to prevent one remote control from controlling several devices at the same time, the remote control has 5 address codes, and these address codes can be set in the Settings menu to realize the "one to one" control between the device and the remote control.

### 4.2 Play music via optical, coaxial or IIS-LVDS port

Connect the unit to standard S/PDIF output devices via optical and coaxial, or connect to MATRIX X-SPDIF 2 via IIS-LVDS port. The signal format and the sampling rate will be displayed when the signal is locked properly. Otherwise, please check whether the cables connected reliably and the front-end device has output signals.

### 4.3 Play music via USB Audio port

Connect the X-SABRE 3 to a computer via a USB type-B to type-A cable, drivers need to be installed when using on a PC with Windows 7/8/10. Find the driver installation package from MATRIX Audio website <https://matrix-digi.com/en/downloads/>, the installation process as follows:

- Install drivers for Windows.

i. Double-click the driver installation package and click "Next".

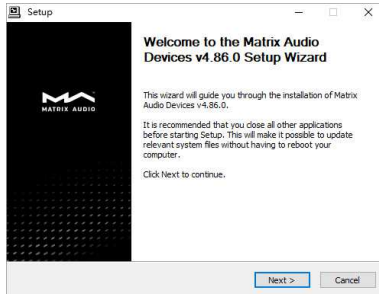

ii. Select installation path and click "Install".

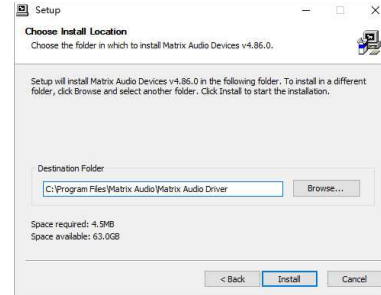

iii. Click "Next" after the installation is complete.

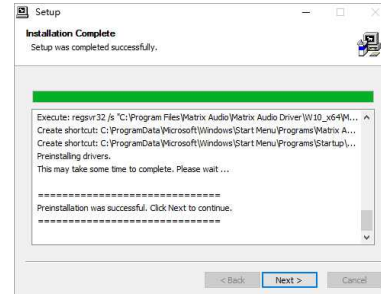

iv. Click "Finish" to close the wizard.

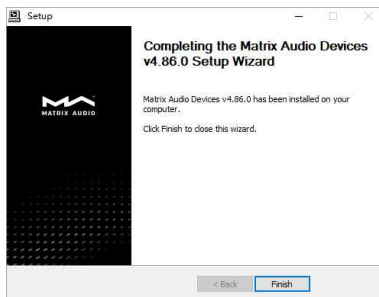

It's no need to install drivers for macOS, select "X-SABRE 3" as audio device in System Preferences.



X-SABRE 3 can be connected to an iPhone or iPad via a Lightning to USB Camera Adapter.  
X-SABRE 3 can be connected to Android devices via an OTG adapter, but not every Android devices are compatible with X-SABRE 3 via OTG connection.

#### 4.4 AirPlay

X-SABRE 3 supports AirPlay 2, when connected to your local area network, you can cast the music to the unit from your iPhone, iPad or MAC via AirPlay. Let the iPhone, iPad and MAC in the same network with this unit, tap AirPlay icon in the Control Center and select "X-SABRE3-XXXX" as playback device, then enjoy the music. The album art image will be displayed on the screen of X-SABRE 3, and the output volume can be controlled by the sender device.

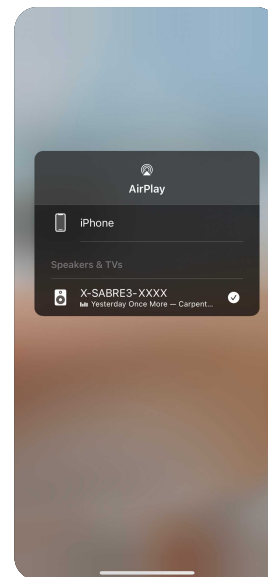



### Roon Ready

X-SABRE 3 has passed Roon Ready certification, you can enable and select this unit from Roon, the audio files will be streamed to the unit bit-perfectly. The album art image of the playing track will be displayed on the device screen. You also can control the output volume, power on and enter standby mode through the Roon controller app.

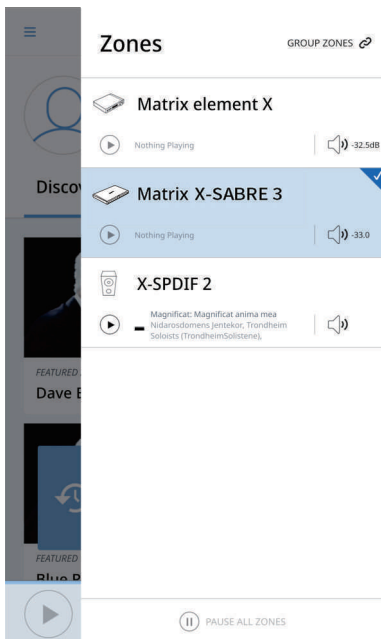

### TIDAL connect

X-SABRE 3 supports TIDAL connect. When connected to the local area network, you can cast the music to X-SABRE 3 from TIDAL app on your mobile devices or computers. Select X-SABRE 3 in the broadcast menu in TIDAL app, as shown below:

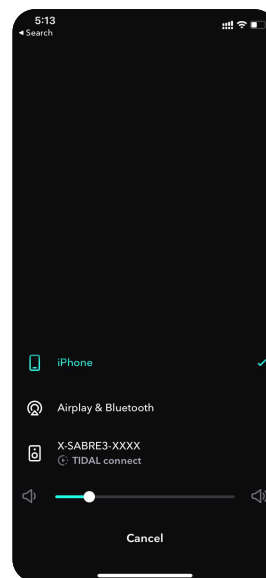

### Spotify Connect

X-SABRE 3 supports Spotify Connect. When connected to the local area network, you can cast the music to X-SABRE 3 from Spotify app on your mobile devices or computers.

Use your phone, tablet or computer as a remote control for Spotify. Go to [spotify.com/connect](https://spotify.com/connect) to learn how.

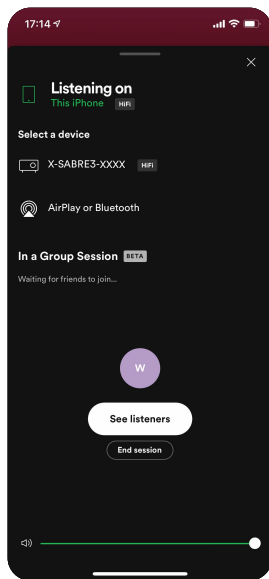

### DLNA/UPnP

X-SABRE 3 supports DLNA/UPnP. When connected to the local area network, you can cast the music to X-SABRE 3 from DLNA/UPnP supported apps on your mobile devices or computers.

DLNA/UPnP is an open protocol, we cannot ensure all the DLNA/UPnP apps are compatible with X-SABRE 3.

### NOTE:

When playing with a higher sampling rate via the network, considering the stability and bandwidth of the wireless connection, please use the Ethernet connection first to get the best playback experience.

## 5. Settings

At Home screen, tap the "⊞" touch-key to enter Settings menu. Use the "<" and ">" touch-key to switch items, tap the "⊞" touch-key again to enter the options of the selected item. As shown below:



You can configure the items according to the instructions on the screen.

## 6. Appendix

### 6.1 About MQA (Master Quality Authenticated)

X-SABRE 3 includes a MQA full decoder, which enables you to play back MQA audio files and streams via USB audio port or from Roon, delivering the sound of the original master recording.

Green or blue dot beside MQA logo indicates that the product is decoding and playing an MQA stream or file, and denotes provenance to ensure that the sound is identical to that of the source material.



Green or blue dot beside MQA logo indicates that the product is decoding and playing an MQA stream or file.



The dot glows magenta to indicate that the unit is rendering an MQA stream or file. This delivers the final unfold of the MQA file.



### 6.2 IIS-LVDS port

The IIS-LVDS port of X-SABRE 3 is based on standard 19-pin HDMI connector. It uses 4 sets of LVDS differential signals to transmit IIS data. It supports up to 32Bit/768kHz PCM signal input and 1Bit/22.4MHz DSD signal input.

X-SABRE 3 is compatible with 4 sets of IIS-LVDS port definitions, you can find the pin definition diagram in "IIS-LVDS definition" option in Settings menu.



The PCM format is the standard IIS format, the DSD format supports native DSD and DoP (DSD over PCM).

## 6.3 Technical Specifications

### Hardware platform

CPU: NXP i.MX 6Quad 4x Cortex-A9 @1.2GHz

D/A Chip: ES9038PRO

Clock Source: Crystek CCHD-950

### Digital Input

Coaxial & Optical:

PCM 16-24Bit /44.1kHz, 48kHz, 88.2kHz, 96kHz,  
176.4kHz, 192kHz

DSD 2.8MHz (DoP)

IIS LVDS:

PCM 16-32Bit /44.1kHz, 48kHz, 88.2kHz, 96kHz, 176.4kHz,  
192kHz, 352.8kHz, 384kHz, 705.6kHz, 768kHz

DSD 2.8MHz, 5.6MHz, 11.2MHz (DoP)

DSD 2.8MHz, 5.6MHz, 11.2MHz, 22.4MHz (Native)

USB Audio:

PCM 16-24Bit /44.1kHz, 48kHz, 88.2kHz, 96kHz, 176.4kHz,  
192kHz, 352.8kHz, 384kHz, 705.6kHz, 768kHz

MQA 16-24Bit /44.1kHz, 48kHz, 88.2kHz, 96kHz, 176.4kHz,  
192kHz, 352.8kHz, 384kHz MQA Studio or MQA stream

DSD 2.8MHz, 5.6MHz, 11.2MHz (DoP)

DSD 2.8MHz, 5.6MHz, 11.2MHz, 22.4MHz (Native)

### Line output

XLR

DNR: > -134dB

THD+N: <0.00010%@1k, <0.00025%@20Hz-20kHz

Frequency Response: 20Hz-20kHz  $\pm 0.05$  -3dB@86kHz

Channel Crosstalk: >-151dB

Output Level: 4.8VRMS

RCA

DNR: > -128dB

THD+N: <0.00015%@1k, <0.00025%@20Hz-20kHz

Frequency Response: 20Hz-20kHz  $\pm 0.05$  -3dB@86kHz

Channel Crosstalk: > -138dB

Output Level: 2.4VRMS

### Network

LAN: 10/100/1000BASE-T

Wi-Fi: 2.4GHz/5GHz

### MA player Lite

Roon Ready

PCM 16-24Bit /44.1kHz, 48kHz, 88.2kHz, 96kHz, 176.4kHz,  
192kHz, 352.8kHz, 384kHz, 705.6kHz, 768kHz

MQA 16-24Bit /44.1kHz, 48kHz, 88.2kHz, 96kHz, 176.4kHz,  
192kHz, 352.8kHz, 384kHz MQA Studio or MQA stream

DSD 2.8MHz, 5.6MHz, 11.2MHz, 22.4MHz

AirPlay2\*  
TIDAL connect \*  
Spotify Connect\*  
DLNA/UPnP\*

\* The audio specs depend on the service provider.

#### 6.4 Power supply

Voltage:

230V position is fit for AC 220V-240V 50/60Hz

115V position is fit for AC 100V-120V 50/60Hz

Standby Power Consumption: <4W

Maximum Power Consumption: <33W

#### 6.5 Other specifications

Weight : 3.4kg(7.49pounds)

Dimension : Width: 310 mm (12.20 inches)

Depth: 218 mm (8.58 inches)

Height: 43 mm (1.69 inches)

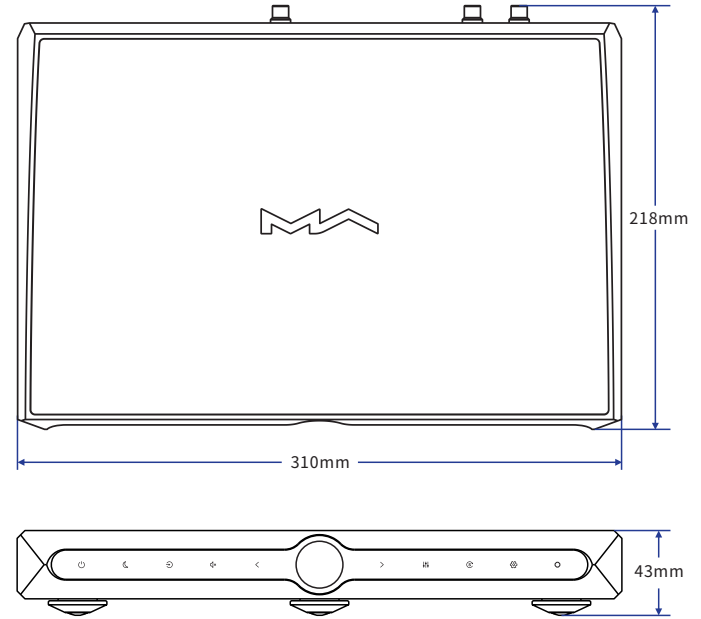

For improvement purpose, specifications subject to changes without prior notice.

## Precautions

- This product is for indoor use only.
- For full ventilation, it is recommended to reserve a space of larger than 5 cm around the device.
- Do not cover the air vents with stuffs such as papers, tablecloths, and curtains to obstruct ventilation.
- Do not place stuffs with flame, such as lighted candles, on the device.
- If the device is used in tropical areas, please be careful to prevent insects from entering the machine through the air vents.
- The device must not be subject to water droplets or splashes. Please do not place stuffs filled with liquids such as vases and cups on or near the device.
- Do not put stuffs around the device power plug and the AC power socket, in order to disconnect the power supply easily when needed.

The product with Hi-Res Audio logo is conformed to High-Resolution Audio standard defined by Japan Audio Society. This logo is used under license from Japan Audio Society.

MQA and the Sound Wave Device are registered trade marks of MQA Limited. ©2016

Being Roon Ready means that Matrix network players transparently discover and connect to Roon without any configuration, and bit-perfect audio is delivered from Roon to your network player.

The Spotify Software is subject to third party licenses found here:

<https://www.spotify.com/connect/third-party-licenses>.

# HIGH PERFORMANCE AUDIO

[www.matrix-digi.com](http://www.matrix-digi.com)

Matrix Electronic Technology Co., LTD  
+86-29-86211122  
B-801, No.111 Fengcheng 5th Rd.,  
Xi'an, China  
[support@matrix-digi.com](mailto:support@matrix-digi.com)

