

GOLD NOTE
Italian Music Experience

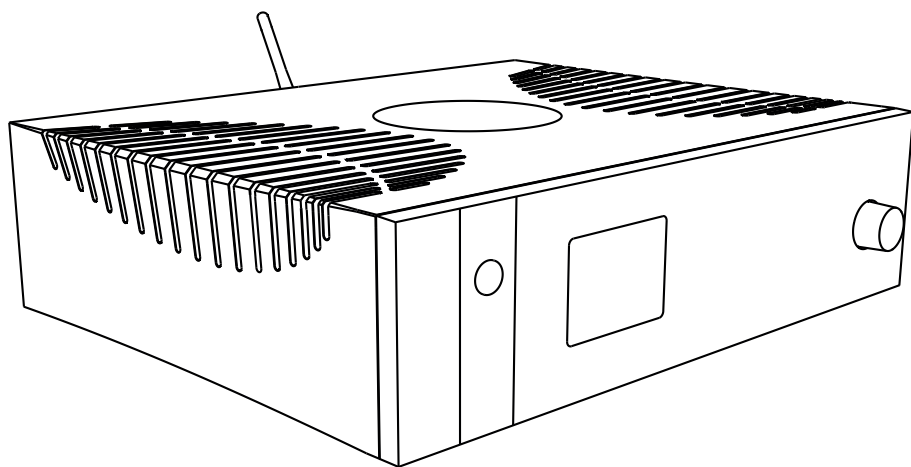

IS-1000

INTEGRATED AMPLIFIER & STREAMER

OWNER'S MANUAL

IMPORTANT SAFETY INFORMATION

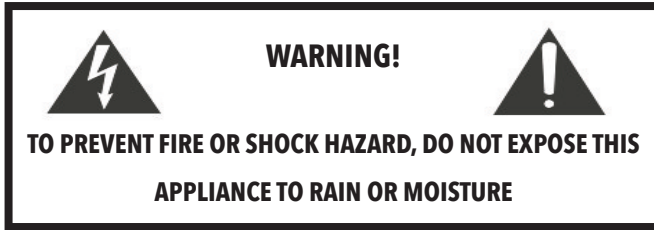

CAUTION!

TO REDUCE THE RISK OF ELECTRIC SHOCK, DO NOT REMOVE COVER (OR BACK).
NO USER-SERVICEABLE PARTS INSIDE.
REFER ONLY TO QUALIFIED GOLD NOTE SERVICE PERSONNEL FOR SERVICE

Do not disassemble any part of the product.

Do not use any part of the product for other purposes.

For service and problems of any kind, contact qualified Gold Note personnel.

Protect the product from rain and humidity and keep away from heat sources, electric and electronic motors etc.

The power Chord supplied must be used only on this unit.

Gold Note does not have responsibility for any improper use of this unit.

This appliance has a serial number located on the rear panel.

Please record the model and serial number and retain them for your records.

Serial Number: _____

Model: _____

IMPORTANT SAFETY INFORMATION

- 1** Read these instructions and store them.
- 2** Heed all warnings.
- 3** Follow the instructions.
- 4** Do not use this apparatus near water.
- 5** Clean only with a dry cloth.
- 6** Do not block the ventilation openings and install in accordance with the manufacturer's instructions.
- 7** Do not install near heat sources such as radiators, heat registers, stoves or other apparatus (including amplifiers) that produce heat.
- 8** Do not defeat the safety purpose of the polarised or grounding-type plug: a polarised plug has two blades with one wider than the other.

A grounding type plug has two blades and a third grounding prong.

The wide blade or the third prong are provided for your safety.

If the provided plug does not fit into your outlet, consult an electrician for replacement of the obsolete outlet.

9 Protect the power cord from being walked on or pinched particularly at plugs, convenience receptacles, and the point where they exit from the apparatus.

10 Only use attachments/accessories specified by the manufacturer.

11 Use only with the cart, stand, tripod, bracket, or table specified by the manufacturer, or sold with the apparatus.

When a cart is used, use caution when moving the cart/apparatus combination to avoid injury from tip-over.

12 Unplug this apparatus during lightning storms or when unused for long periods of time.

13 Refer all servicing to qualified service personnel only.

Servicing is required when the apparatus has been damaged in any way (such as when the power cord or plug is damaged, liquid has been spilled or objects have fallen into the apparatus, the apparatus has been exposed to rain or moisture) and in any case when the apparatus does not operate normally or has been dropped.

DESCRIPTION & SPECIFICATIONS

IMAGINE A COMPLETE HIGH-END STEREO SYSTEM ENCLOSED IN A BEAUTIFUL CHASSIS CARVED IN BOLD ITALIAN STYLE:

With the knowledge and the experience developed in over 20 years of research, we are now able to offer an all-in-one solution powered by the most advanced technologies and components to achieve true audiophile quality sound.

IS-1000 is an advanced fully integrated amplifier that redefines the way music playback is experienced to achieve a new pinnacle in High-End audio, seamlessly merging an Integrated Amplifier, a Phono Preamp, a DAC and a Streamer in a unique, complete source.

The refined technical innovations of IS-1000 come directly from our flagship models, like the preamplifier P-1000 and the power amplifier PA-1175, which inspired us to create a new source that would integrate the analogue components of a high quality amplifier with the digital technologies of a Streamer and a DAC to deliver outstanding performances.

IS-1000 is a Roon Ready device, fully compatible with multi-room systems and with a quick plug&play installation: simply plug IS-1000 to the main A/C, connect it to your network (Wi-Fi or Ethernet) then to the speakers and start to explore the endless possibilities of music, streaming from Tidal & MQA via Tidal, Qobuz, Spotify & Spotify Connect and Deezer with Roon and our App available for iOS and Android.

You can also browse your collection of digital music stored on NAS, HDD and USB sticks (DSD64 via DoP on USB and LAN, PCM up to 24/192).

You don't need anything else to experience at home the pleasure of high definition audio, just IS-1000 and your speakers. If you love vinyl records, connect your turntable directly into IS-1000 to use the Phono Preamp we designed and engineered, it's really that simple.

The Heart of IS-1000 is the powerful integrated amplifier that offers 125W @ 8Ω developed using only the best audio grade components specifically chosen to deliver the ultimate performance.

The Mind of IS-1000 is the advanced streamer based on the latest technology to guarantee perfect connectivity and access HQ music on TIDAL, QOBUZ, SPOTIFY and DEEZER and also the HQ web radio with V-TUNER.

No other cables, no additional boxes. Just endless music in High Resolution.



DESCRIPTION & SPECIFICATIONS

MAIN DETAILS

Class A/B High-Current Mosfet Integrated Amplifier
(125W @ 8Ω)

High-Res Streaming TIDAL, QOBUZ, SPOTIFY, DEEZER

Remote control via App for iOS & Android

Airplay & Roon Ready

UPnP & DLNA supported

DAC: high quality BurrBrown chipset
(PCM1796, PCM1792A)

Phono Stage MM/MC

DIGITAL INPUTS

PCM up to 24bit/192kHz

3 optical (TOS)

1 Coaxial (COAX)

1 USB type A (DSD64 via DoP)

1 Ethernet LAN & Wi-Fi (DSD64 via DoP)

ANALOG OUTPUTS

1 RCA variable

1 RCA fixed

ANALOG INPUTS

1 XLR balanced

1 RCA Line & Phono MM/MC

1 RCA Line & AV-Ind

DIMENSIONS & WEIGHT

Dimensions: 430mm W | 135mm H | 375mm D

Weight: 18Kg

POWER

Main supply: 100V to 245V ~ 50/60Hz

Power consumption: 30W - 400W max

Standby consumption: < 0,5W

FINISHES

Brushed anodised Aluminium available in Black, Silver or Gold

FRONT PANEL

FRONT PANEL OVERVIEW

IS-1000 is a true High-End integrated amplifier and offers unique features to deliver the best audio quality.

Everything has been designed to provide the best experience and thanks to the exclusive **SKC** [*Single Knob Control*] the unit becomes a friendly plug-and-play source that can be fully controlled without even using the remote.

All the information and features are easy to read on the display at any time that is designed to let you have complete control.

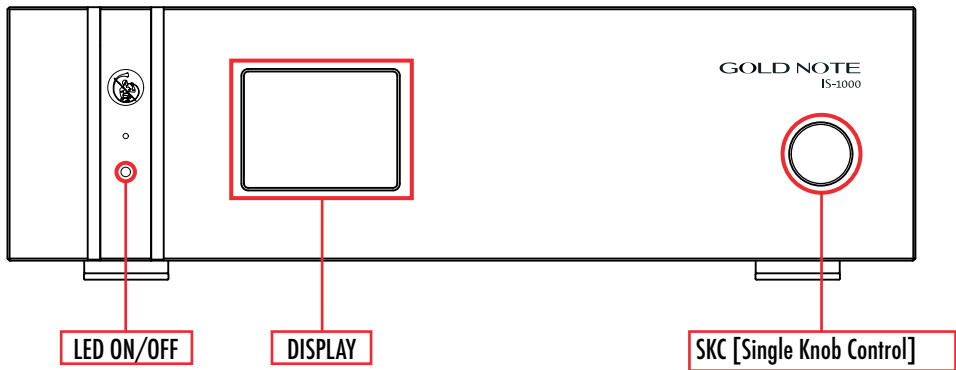

TURNING ON/OFF IS-1000

to turn ON/OFF the unit:

1. Turn ON the MASTER SWITCH located on the rear panel
2. Press and hold the knob on the front panel for 3 seconds

SELECTING A FUNCTION

1. press the knob once to activate the SELECTION FRAME
2. turn the knob left or right until the desired function is highlighted by the SELECTION FRAME then press the knob to select it
3. the frame will turn red: now you can turn the knob to change the function
4. press the knob again when the desired value is set to confirm and exit the selection

DISPLAY

FUNCTIONS & INFORMATION

The display of IS-1000 shows all the information in a clear, easy way to read.

Every function can be selected and adjusted quickly using the knob, the remote and the App .

Adjustments are applied on the go even during playback.

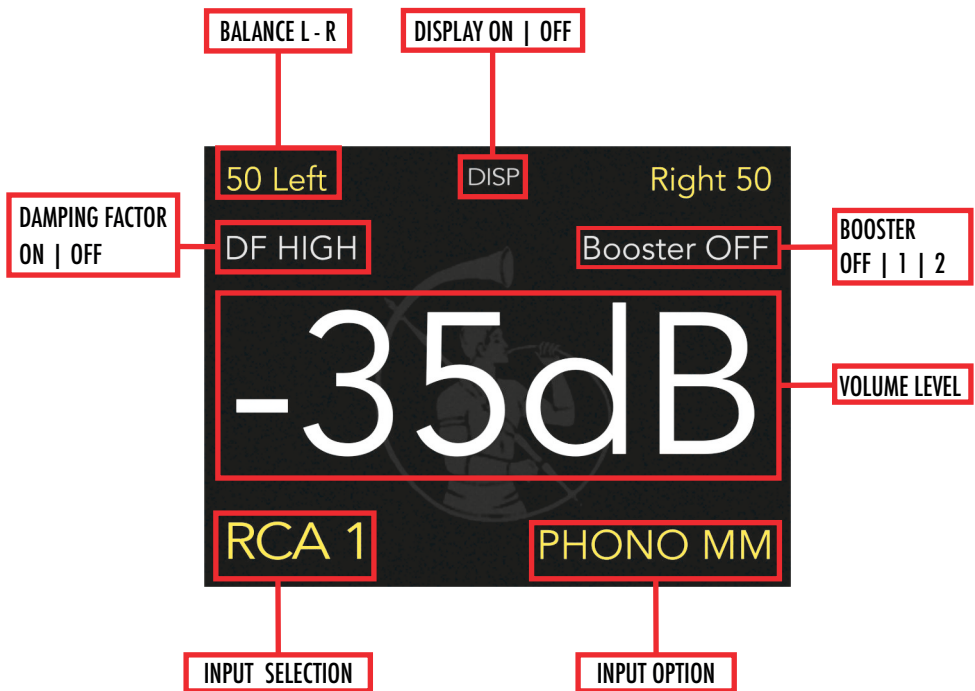

For further details about the features and the functions, please see **page 14**.

You will find a comprehensive guide to use IS-1000 in the most appropriate way in order to achieve the best audio performance with your loudspeakers and environment.

REAR PANEL

REAR PANEL OVERVIEW

IS-1000 features a wide selection of connections to offer the best versatility and become the core of a real High-End system that will deliver audio with true audiophile quality:

6 digital inputs (PCM up to 24bit/192kHz & DSD64 via DoP)

3 analogue inputs (1 XLR balanced and 2 RCA unbalanced)

2 analogue outputs (variable and fixed)

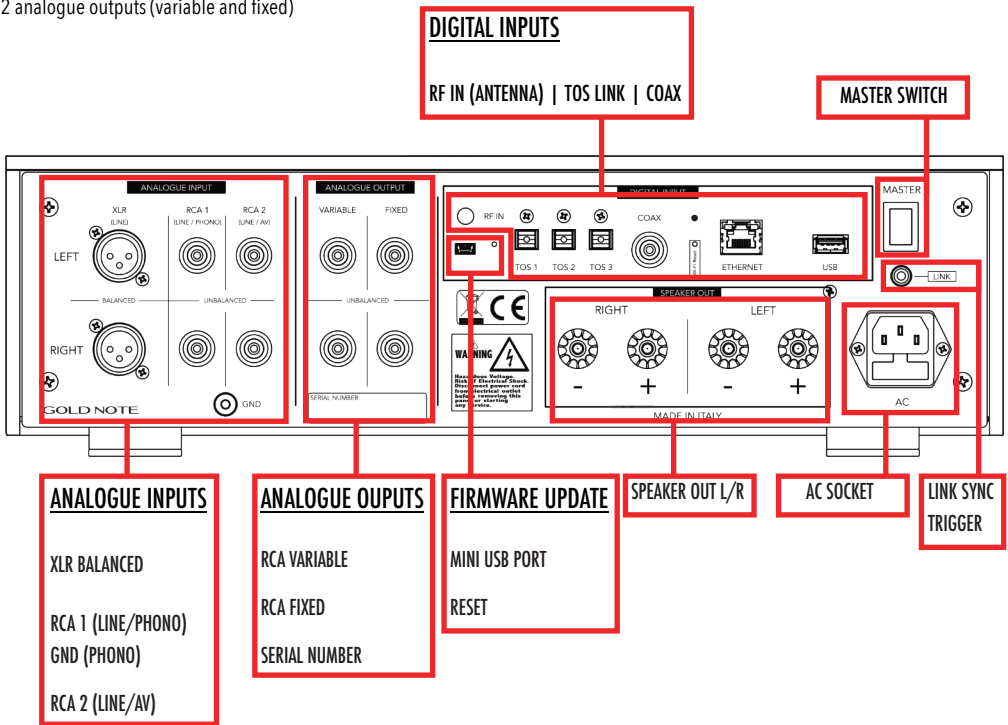

QUICKSTART

QUICKSTART GUIDE

IS-1000 is a Plug&Play source that simply requires only to be connected to the AC, the Internet and your speakers.

1. connect IS-1000 to your speakers via the SPEAKER OUT connectors
2. connect IS-1000 to your network via ETHERNET LAN or Wi-Fi [see page 12]
3. connect IS-1000 to the AC using the supplied power cord
4. connect other sources as a CD player or a turntable via XLR or RCA [see page 12]
5. turn ON the master switch on the rear panel and then press and hold the knob for 3 seconds
6. download the control App for iPhone & iPad and Android [see page 7]
7. open the App [the smartphone/tablet must be connected to the same network used by IS-1000]

IMPORTANT:

please ensure the unit is OFF while handling the cables and connectors

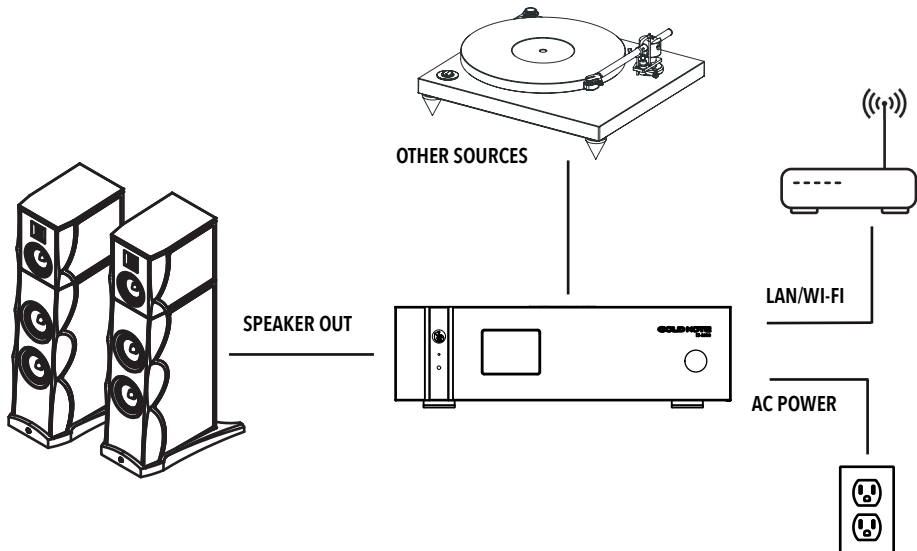

CONTROL APP

DOWNLOAD THE CONTROL APP

Download the [Mconnect Control](#) App from the Apple Store or the Google Play Store to get started.

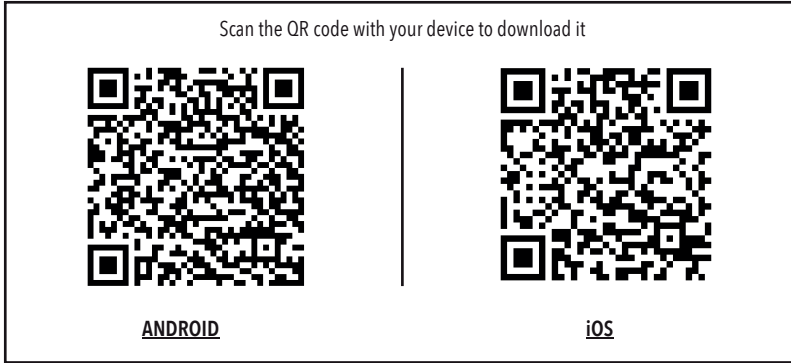

CONTROL APP

DEVICE SETUP & INFO

- Device Setup
- Cloud Setup
- Sort Tracks
- Rate on AppStore
- Contact Conversdigital
- App Info



DEVICE INFO

Gapless playback is available here

Device Information

IS-1000

GN GOLD NOTE
IS-1000

IP : 192.168.3.28
Firmware Version : 3.4.2

Gapless

Service : DMS,TIDAL,Deezer,Qobuz

DEVICE SETUP

WIFI NETWORK SELECTION

connect the device to a different Wi-Fi network

DEVICE NAME CHANGE

rename the device on the network

LAN STATIC IP ADDRESS SETUP

WIFI STATIC IP ADDRESS SETUP

FIRMWARE UPDATE

if there is a new update for the firmware the app notifies it and let you update the IS-1000

IS-1000

IS-1000

WiFi Network Selection >

Device Name Change >

Device Information

WiFi SSID Gold Note Router 2.4Ghz

LAN IP [gear icon]

WiFi IP 192.168.3.28 [gear icon]

LAN MAC 98:5E:1B:00:3D:D9

WiFi MAC 70:F1:1C:01:5D:EA

F/W goldnote_1 cu_Bd v3.4.2

S/N CDM212106170248

CONTROL APP

CLOUD SETUP

In CLOUD SETUP you can turn ON/OFF all the streaming services available on IS-1000 such as: TIDAL , QOBUZ, DEEZER, VTUNER

You can also turn ON/OFF the cloud storage services, such as: DROPBOX and ONEDRIVE

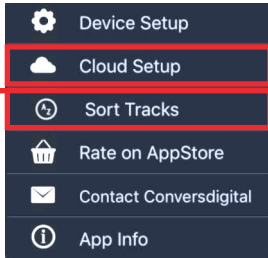

CLOUD SETUP

enable and disable:

- STREAMING SERVICES
- CLOUD SERVICES

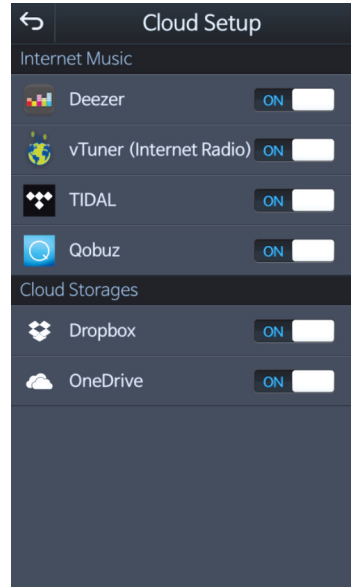

SORT TRACKS

Music tracks in a folder can be sorted by track number and track name.

It can be applied even for each folder.

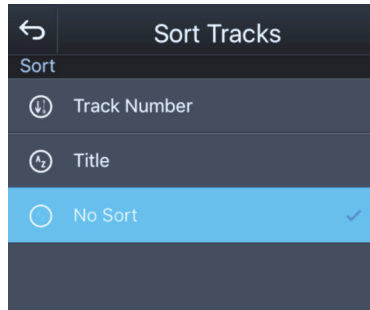

CONTROL APP

PLAY TO & BROWSER

PLAY TO

Select the "Play To" tab and then select IS-1000.

The IS-1000 must be connected to the same network the mobile device is using.

If the App doesn't show the IS-1000 it is most likely due to the fact the mobile device is connected to a different network than the IS-1000.

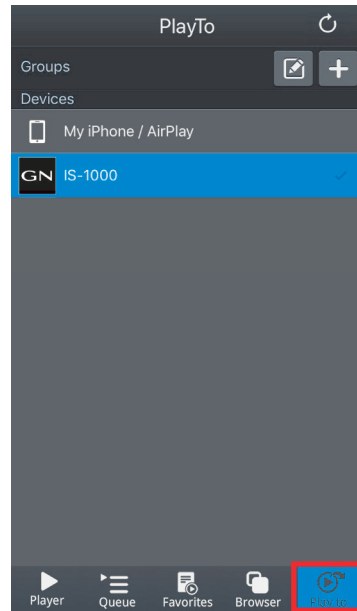

BROWSER

In the "Browser" tab choose the source of the music:

STREAMING SERVICES

TIDAL | Qobuz | Deezer | VTuner

CLOUD STORAGE SERVICES

Dropbox | OneDrive

LOCAL SERVERS

Network NAS and UPnP/DLNA services

USB flash drives are listed as "IS-1000 Server"

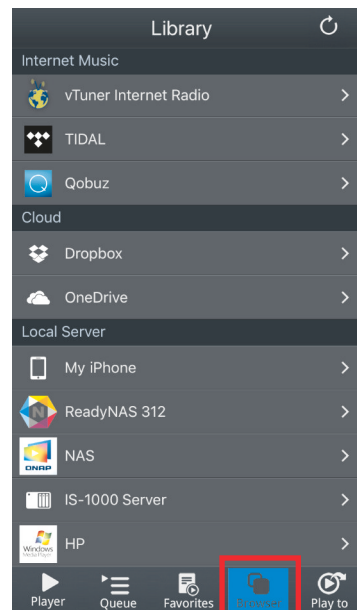

CLOUD SETUP

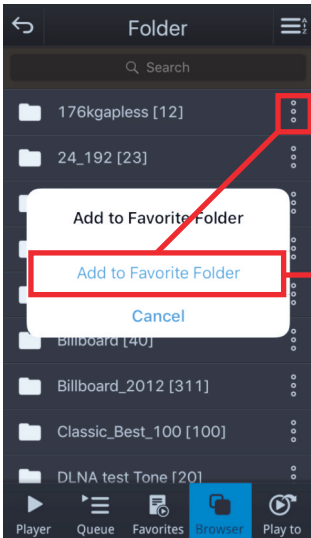

FAVORITES

Add folders and tracks to your Favorites list. The folder/tracks will be listed in the Favorites tab.

You can find the Favorites tab in the bottom menu.

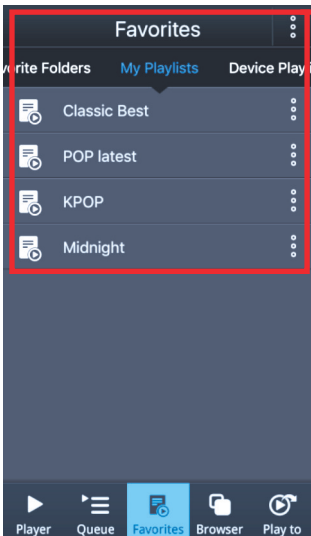
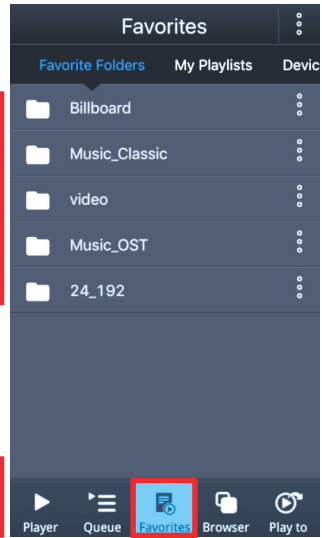

MY PLAYLISTS

New playlists can be created and edited from the Favourites tab. Use this tab to manage your playlists, rename or delete them.

You can also create a new playlist while browsing music on Streaming services and local servers.

If you don't want to create a new Playlist, simply add the tracks to the temporary **Queue**.

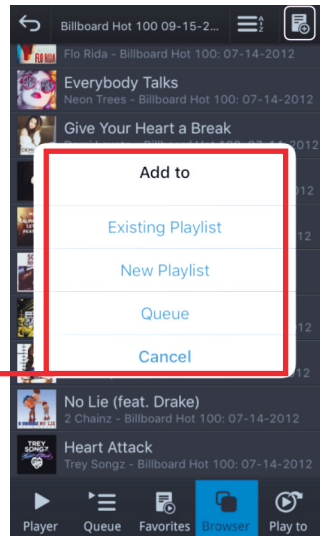

NETWORK SETUP

WLAN CONNECTION

IS-1000 supports Wired LAN and Wi-Fi connection.

To use a Wired LAN connection simply plug the cable into the Ethernet port on the rear panel of IS-1000 and you are ready to go.

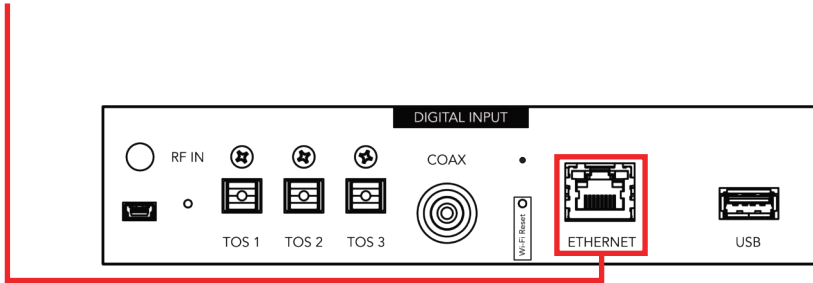

WI-FI CONNECTION VIA WPS

The easiest way to connect IS-1000 to your network via Wi-Fi is to use the **WPS [Wi-Fi Protected Setup]** function if available on your router:

1. use the tip of a paper clip to press and hold for 10 seconds the Wi-Fi Reset button on the rear panel of IS-1000, release it when the blue led is flashing
2. press the WPS button on your router (please refer to its instruction manual)
3. wait until IS-1000 is connected to your network
4. the flashing led turns into a steady light when the IS-1000 is connected

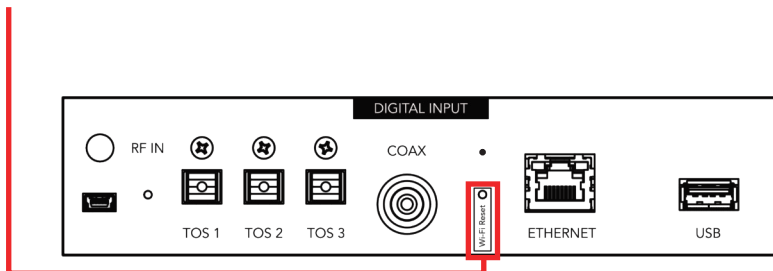

NETWORK SETUP

IS-1000 WIFI WIZARD CONNECTION

In case your router doesn't feature the WPS connection, use the Wi-Fi Wizard Connection:

1. use the tip of a paper clip to press and hold for 4~5 seconds the Wi-Fi Reset button on the rear panel of IS-1000.

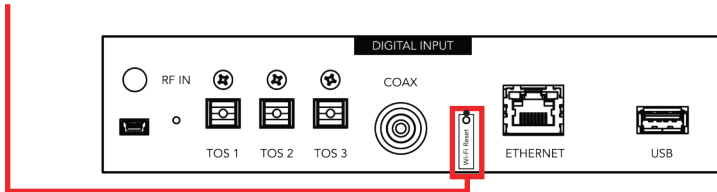

2. IS-1000 will create its own wireless network, when the blue led light is flashing the new network is ready
3. turn ON the Wi-Fi on your mobile device and scan the networks to find *GOLD-NOTE_XXX*
4. connect to *GOLD-NOTE_XXX* using "password" as password
5. open the App and go into DEVICE SETUP > Wi-Fi Network Selection [see page 8]
6. here are listed the wireless connections available, select the one you want to use with IS-1000
7. IS-1000 is now connected to the selected Wi-Fi network
8. connect your mobile device to the same network used by IS-1000

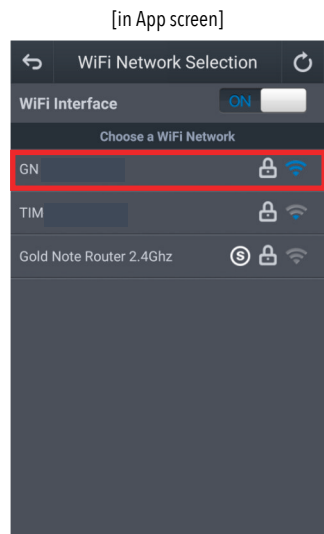
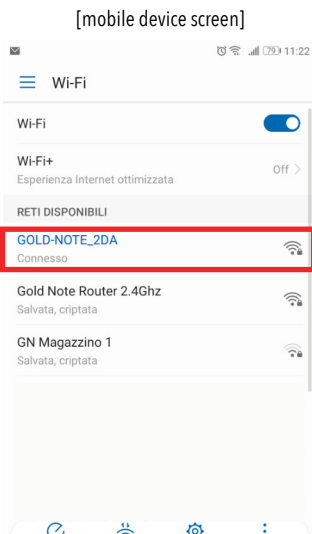

FEATURES AND FUNCTIONS

IS-1000 is an advanced integrated amplifier developed using proprietary technologies and features, a machine designed to offer the best audiophile sound quality with contemporary ease of use and versatility in order to always deliver a great performance with a large variety of loudspeakers.

BALANCE L/R

adjust the balance of the volume level on the Left and Right channel

DISP

turn the display ON or OFF
when the display is OFF, use the knob or the remote to turn it ON again temporarily

VOLUME

the volume level is always displayed in the middle of the screen to be easily readable

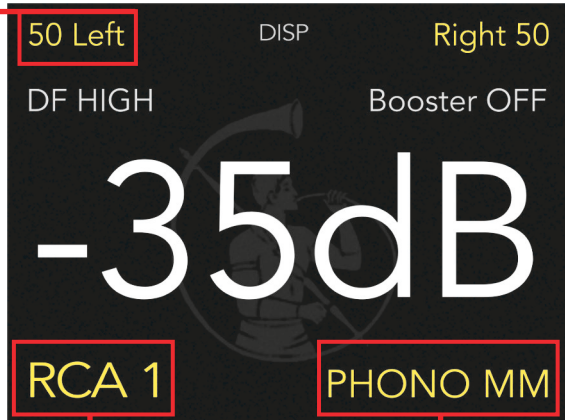

INPUT SELECTION

NETWORK - select this input to use the streaming services and for music on local servers [see page 10]

XLR - balanced input to connect additional sources from your system, like a CD Player

RCA 1 - input to connect additional sources or to use the built-in phono stage [select then PHONO MM/MC]

RCA 2 - input to connect additional sources or AV processors

TOS 1, 2, 3 - digital inputs to connect additional sources, like a TV etc.

COAX - digital inputs to connect additional sources, like a TV etc.

DF - HIGH/LOW

the Damping Factor can be set on HIGH [250] or LOW [25] to drive properly any kind of speakers:

HIGH - gives the best of a solid state amp and it's an ideal match for big speakers with mid/low sensitivity

LOW - is ideal to drive high-sensitivity speakers and mini-monitor as IS-1000 will act as a low-power tube amp

BOOSTER - OFF/1/2

The preamp features our proprietary BOOSTER technology to drive speakers that require a robust power supply providing greater energy in a very specific range of low frequencies and for difficult environments.

BOOSTER is completely by-passed when set on OFF.

REMOTE

USING THE REMOTE

IS-1000 is supplied with a Gold Note remote to help you conveniently operate the amplifier without even touching the knob located on the frontal panel.

With the remote you can fully access every function just like you would when using the knob.

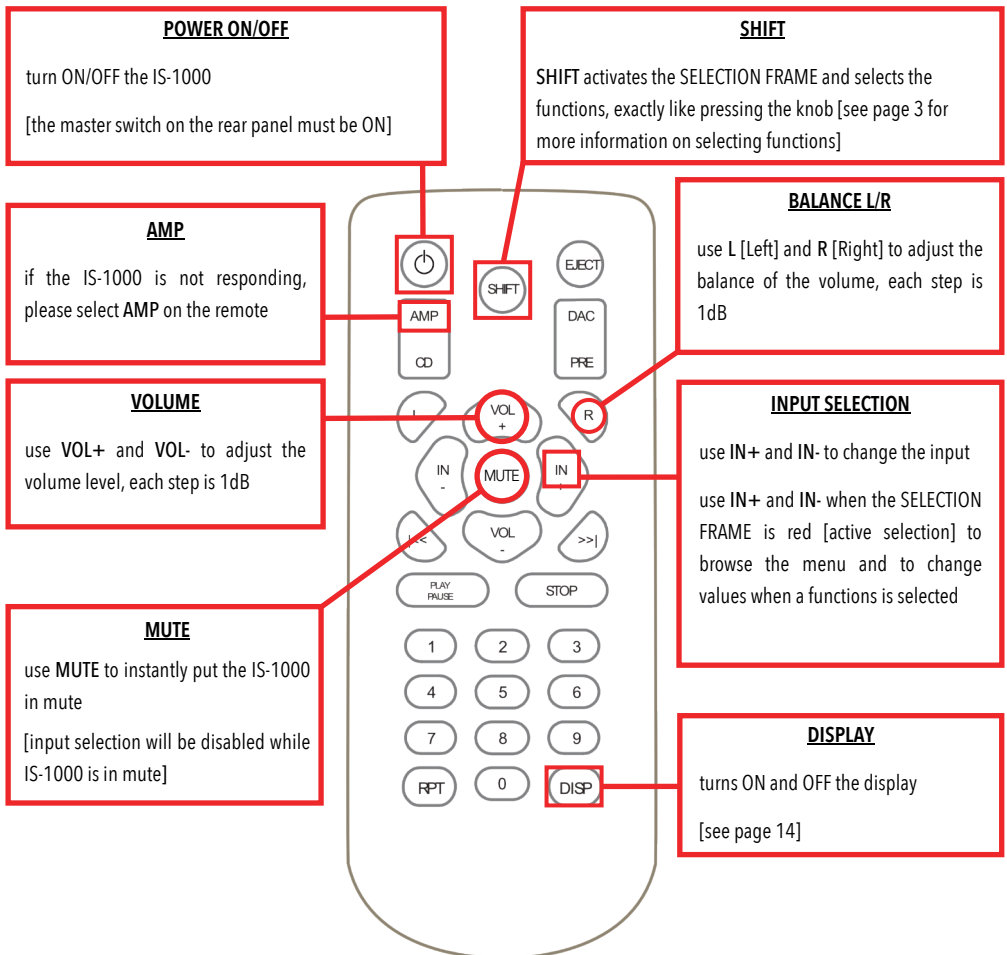

CONNECTING OTHER SOURCES

CONNECTING SOURCES VIA ANALOGUE INPUT

You can connect external audio sources to IS-1000 through the analogue input connectors located on the rear panel using the unit as a pure Integrated Amplifier.

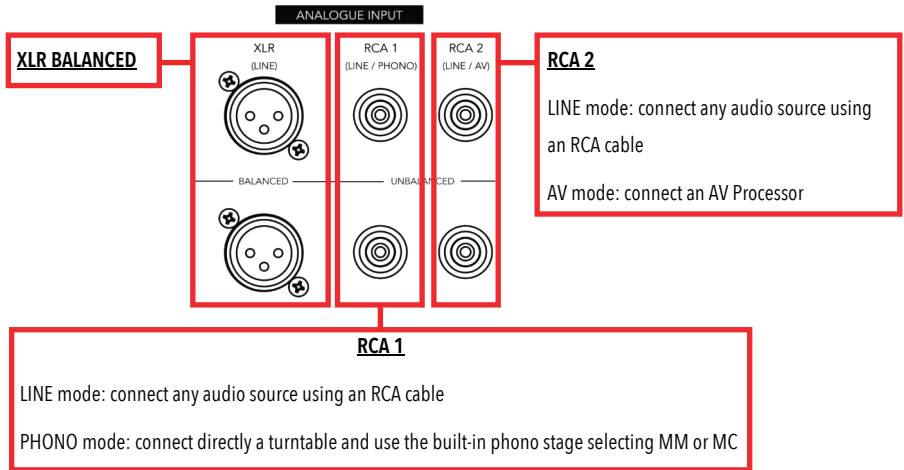

CONNECTING SOURCES VIA DIGITAL INPUT

External digital sources can be connected to the IS-1000 through the digital input connectors TOS and COAX located on the rear panel.

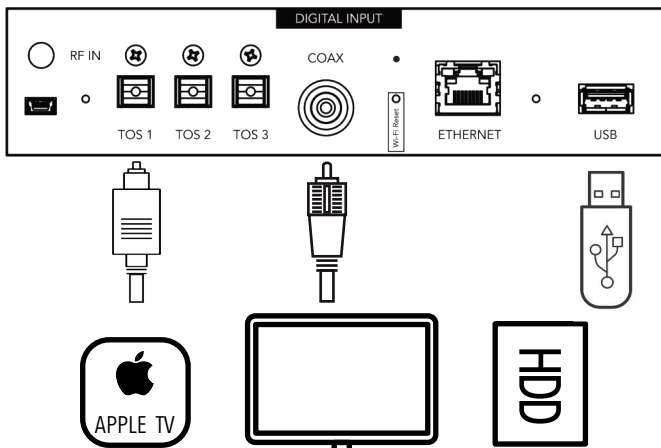

IMPORTANT NOTES

PLEASE NOTE

The **WiFi Interface** must remain ON in order to control the IS-1000 and disabling it will cause the IS-1000 to be impossible to reach via App even when using a cabled connection (LAN via Ethernet).

The WiFi Interface allows the connection between the App and the IS-1000.

If you are using the IS-1000 in wireless mode (connected via Wi-Fi) and wish to switch to the cable mode (LAN) simply connect the Ethernet cable using the dedicated port available on the rear panel of IS-1000.

Once the cable is connected the IS-1000 will automatically switch mode and disable the Wi-Fi connection.

Wait for the blue LED located on the rear panel to turn OFF for confirmation that IS-1000 is using the LAN.

PLEASE LEAVE THE WIFI INTERFACE ON AT ANY TIME

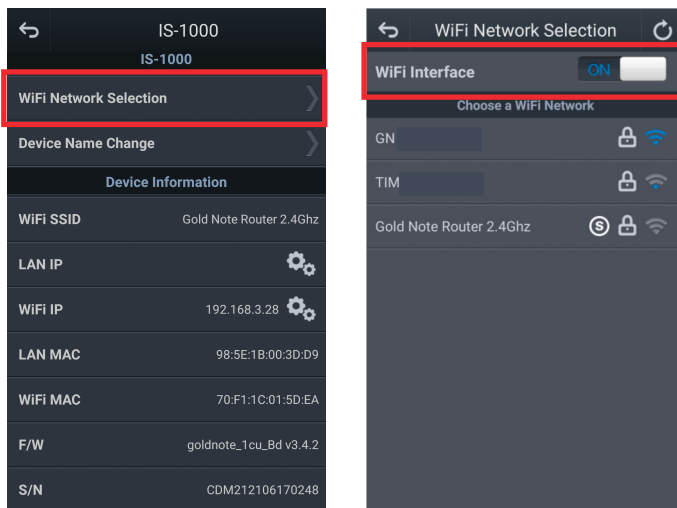

IN CASE WIFI INTERFACE IS ACCIDENTALLY SWITCHED OFF

To enable the remote control via App the WiFi Interface must be switched ON.

Please follow the procedure explained at page 13 IS-1000 WiFi WIZARD MODE to enable it and then connect IS-1000 to your WiFi network

WARRANTY & SERVICE

WARRANTY

To validate the warranty is necessary to register the unit on the Gold Note internet web site within 15 days from the purchase on the appropriate area of the web site:

www.goldnote.it/warranty

If the unit is not registered correctly or has been purchased from a different country of the purchaser home address the unit will not be covered by any warranty and the registration will be refused.

The warranty does not does not cover in any case: Tubes, Phono Cartridge Styli and Batteries.

SERVICE

Every GOLD NOTE® product is the result of meticulous technological research, and consequently their correct functioning is guaranteed. In spite of this it is possible that problems may emerge which non-specialist users cannot resolve.

In this case, contact your dealer to be advised on how the fault can be solved.

Do not return any object directly to the factory or to the national distributor or without being authorised to do so.

In such cases both GOLD NOTE® and the distribution agents operating within your territory decline responsibility of any kind.

For more information please visit www.goldnote.it/service

PLEASE NOTE

Descriptions and technical characteristics may vary at any time and without notice.

TROUBLESHOOTING

TROUBLESHOOTING

PROBLEM	CAUSE	SOLUTION
The GN remote doesn't control the IS-1000	The GN remote can be used to control more than one unit. To control each unit the correct mode must be selected on the remote.	Select AMP mode on the remote. The button "AMP" is located in the upper part of the remote. See page 17 for more information.
The App can't find the IS-1000 in the network	The IS-1000 is not connected to the network.	Make sure the IS-1000 is connected to the WLAN or LAN either with the Ethernet cable or the Wi-Fi. See page 14/15 for more information.
		Make sure the RF antenna is correctly installed. It may be impossible to use the IS-1000 with the Wi-Fi if the RF antenna is not installed.
		When using the Wi-Fi, make sure the IS-1000 is connected to the correct WLAN. Don't forget to put in the password to complete the connection if required by your network setup.



GOLDNOTE

Italian Music Experience

www.goldnote.it